

### Primary Characteristics

$I_F$	1	A
$V_{RRM}$	50~1000	V
$I_{FSM}$	30	A
$V_F$	1.1	V

### Features

- High current capability
- High surge current capability
- Low reverse current
- Component in accordance to RoHS 2002/95/EC

### Mechanical Data

- Cases: DO-214AC(SMA)
- Case Material: Molded Plastic. UL Flammability Classification Rating 94V-0
- Terminals: Lead free Plating (Tin Finish)  
Solderable per MIL-STD-202, Method 208
- Polarity: Cathode Band
- Weight: 0.062 grams (approximate)

### Package Outline Dimensions

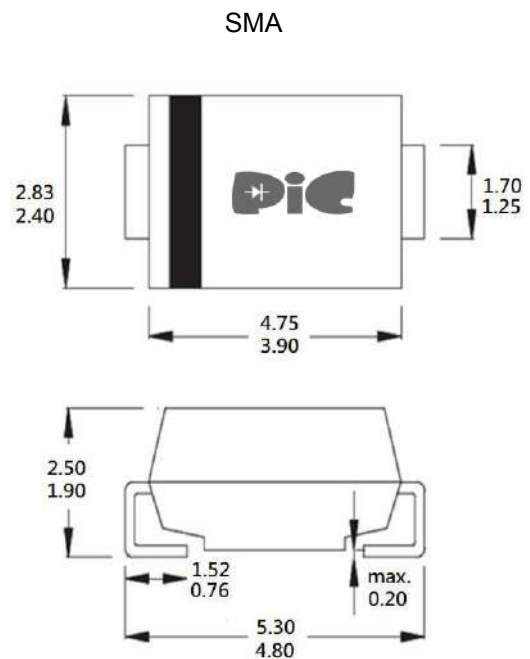

Dimensions in inches and millimeters

### Maximum Ratings (TA=25°C unless otherwise noted)

PARAMETER	SYMBOL	FM4001	FM4002	FM4003	FM4004	FM4005	FM4006	FM4007	UNIT
Maximum repetitive peak reverse voltage	$V_{RRM}$	50	100	200	400	600	800	1000	V
Maximum RMS voltage	$V_{RMS}$	35	70	140	280	420	560	700	V
Maximum DC blocking voltage	$V_{DC}$	50	100	200	400	600	800	1000	V
Maximum average forward rectified current	$I_F$	1.0							A
Peak forward surge current, 8.3ms single half sine-wave superimposed on rated load	$I_{FSM}$	30.0							A
Maximum Instantaneous Forward Voltage IF=1A @ 25°C	$V_F$	1.1							V
Maximum DC Reverse Current @ TA=25°C at Rated DC Blocking Voltage @ TA=100°C	$I_R$	5 50							uA
Typical Junction Capacitance(NOTE1)	$C_j$	10							pF
Typical Thermal Resistance	$R_{\theta JC}$	70							°C/W
Operating Temperature Range	$T_J$	-55 to +150							°C
Storage Temperature Range	$T_{STG}$	-55 to +150							°C

### NOTES:

1. Measured at 1.0MHZ and applied reverse voltage of 4.0V DC

### Rating and Characteristics Curves

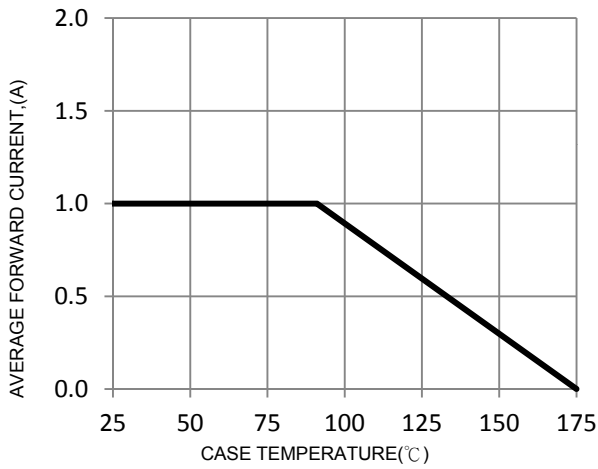

FIG. 1-Typical Forward Current Derating Curve

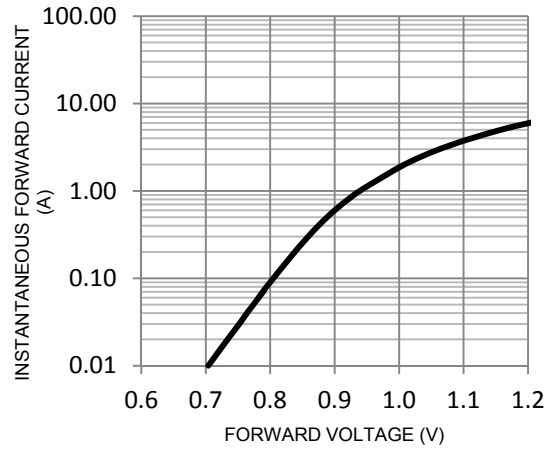

FIG. 2-Typical Forward Characteristics

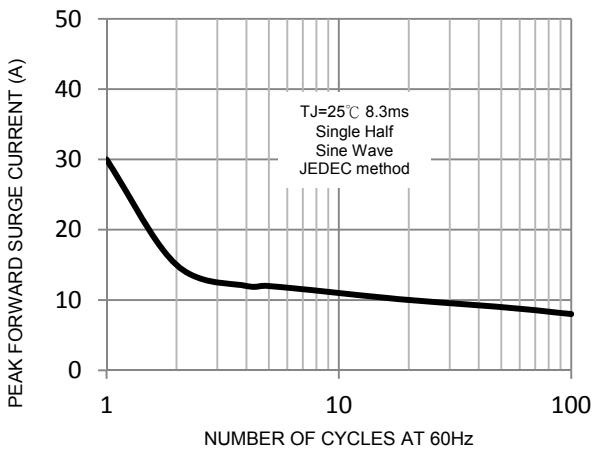

FIG. 3-Maximum Non-Repetitive Forward Surge Current

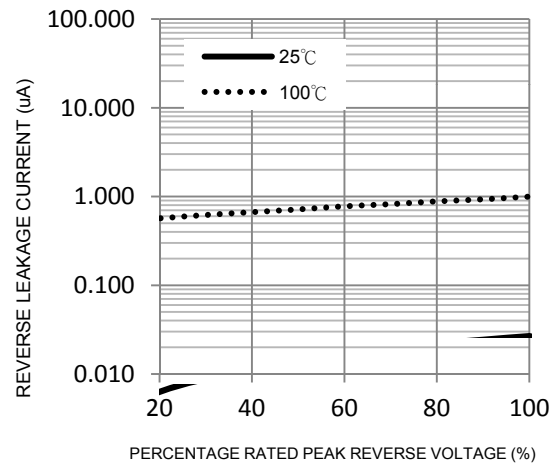

FIG. 4-Typical Reverse Characteristics

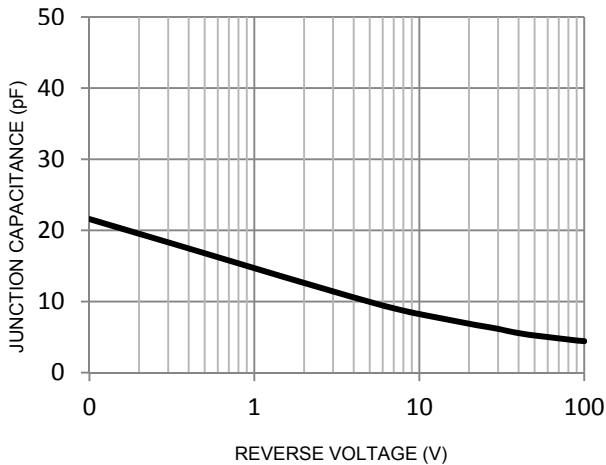
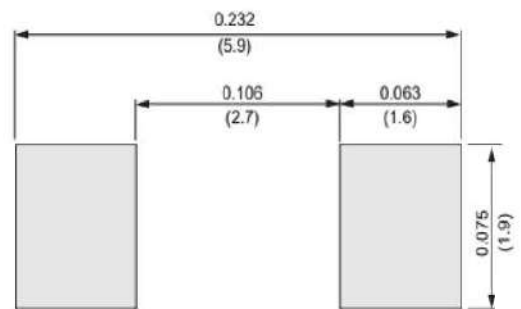

FIG. 5-Typical Junction Capacitance

### Suggested Pad Layout



Unit:mm

### Packaging Specifications

Package	A0 (mm)	B0 (mm)	K0 (mm)	D0 (mm)	E (mm)	F (mm)	P0 (mm)	P1 (mm)	P2 (mm)	T (mm)	W (mm)
SMA	2.8±0.1	5.33±0.1	2.36±0.1	1.55±0.1	1.75±0.1	5.50±0.1	4.0±0.1	4.0±0.01	2±0.1	0.25±0.1	9.4±0.1
SMB	3.8±0.1	5.40±0.1	2.45±0.1	1.55±0.1	1.75±0.1	5.50±0.1	4.0±0.1	8.0±0.01	2±0.1	0.25±0.1	9.4±0.1
SMC	6.05±0.1	8.31±0.1	2.54±0.1	1.55±0.1	1.75±0.1	7.50±0.1	4.0±0.1	8.0±0.05	2±0.1	0.25±0.1	12±0.1

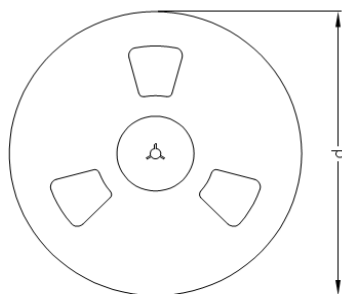
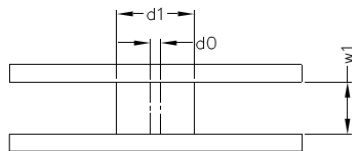
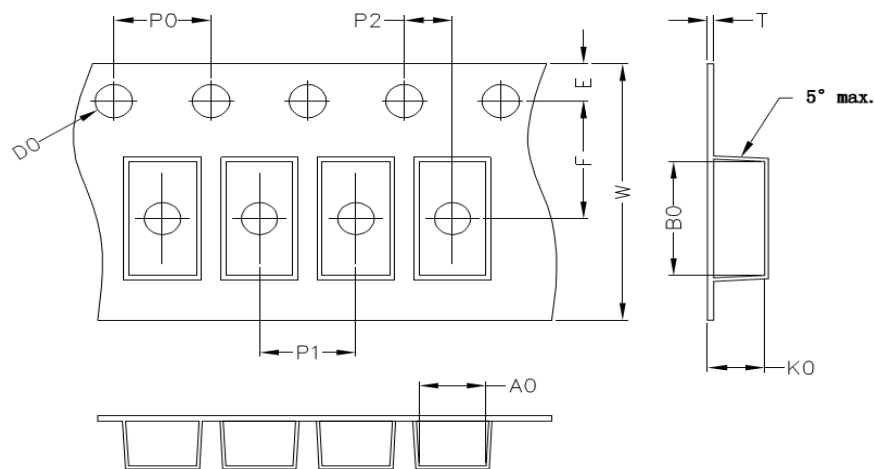

Package	D1 (mm)	D0 (mm)	W1 (mm)	D (mm)
SMA	75	13.5	13.5	330
SMB	75	13.5	13.5	330
SMC	75	13.5	17.0	330

NOTE : The tolerance of reel is ±2mm

### Recommend IR Reflow Soldering Thermal Profile

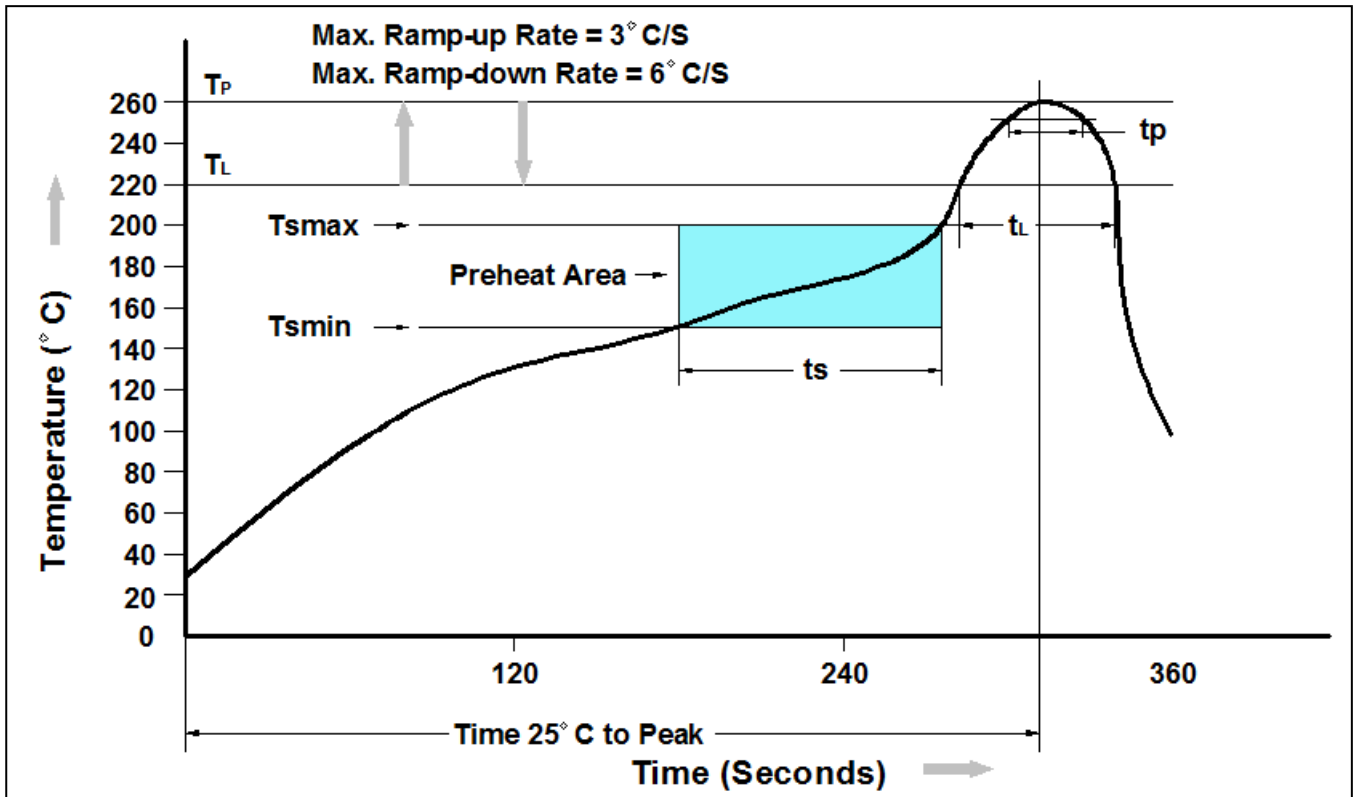

Profile Feature	Pb-Free Assembly Profile
Temperature Min. (T Amin)	150°C
Temperature Max. (T smax)	200°C
Time (ts) from (T Amin to T smax)	60-120 seconds
Average Ramp-up Rate (tL to tP)	3°C/second max.
Liquidous Temperature (TL)	217°C
Time (tL) Maintained Above (TL)	60 – 150 seconds
Peak Temperature	260°C +0°C / -5°C
Time (tP) within 5°C of actual Peak Temperature	30 seconds
Ramp-down Rate (TP to TL)	6°C/second max
Time 25°C to Peak Temperature	8 minutes max.

### Ordering Information

Part Number	Description	Quantity
FM4001~FM4007	SMA Reel	5000 pcs

### DISCLAIMER

- The information in this document and any product described herein are subject to change without notice and should not be construed as a commitment by Paceleader, Paceleader reserve the right to make changes to the information in this document.
- Though Paceleader make effort to improve product quality and reliability, Product can malfunction and fail due to their inherent electrical sensitivity and vulnerability to physical stress, it is the responsibility of the customer, when utilizing Paceleader products, to comply with the standards of safety in making a safe design for entire system and to avoid situation in which a malfunction or failure., In developing a new designs, customer should ensure that the device which shown in this documents are used within specified operatingranges.
- The information contained herein is presented only as a guide for the applications of our products. No responsibility is assumed by Paceleader for any infringements of patents or other rights of the third parties which may result from its use.