

Characteristics

I_o	1.0	A
V_{RRM}	50~1000	V
I_{FSM}	30.0	A
V_F	1~1.70	V

Features

- The plastic package carries Underwriters Laboratory Flammability Classification 94V-0
- For surface mounted applications
- Ultra fast switching for high efficiency
- Low reverse leakage
- Built-in strain relief, ideal for automated placement
- High forward surge current capability
- High temperature soldering guaranteed:
260 °C /10 seconds at terminals
- Glass passivated chip junction

Mechanical Data

- Case: JEDEC SMA molded plastic body
- Terminals: Solder plated, solderable per MIL-STD-750 Method 2026
- Polarity: Color band denotes cathode end

Package Outline Dimensions

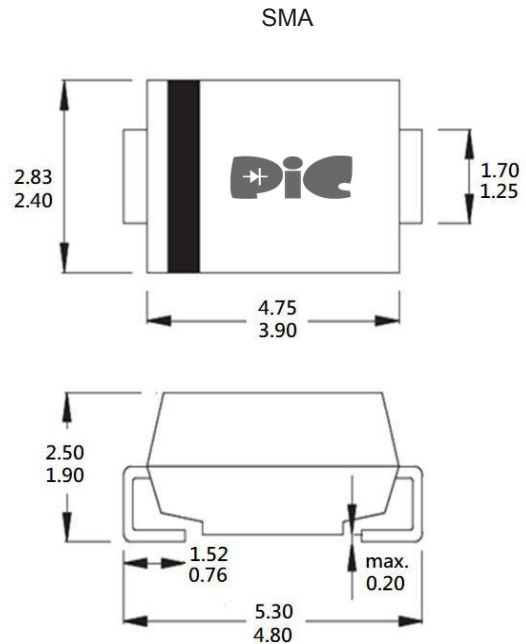

Unit : millimeters

Maximum Ratings (TA=25°C unless otherwise noted)

	Symbol	US1A	US1B	US1D	US1G	US1J	US1K	US1M	UNITS
Marking Code	-	US1A	US1B	US1D	US1G	US1J	US1K	US1M	-
Recurrent Peak Reverse Voltage	V_{RRM}	50	100	200	400	600	800	1000	Volts
RMS Voltage	V_{RMS}	35	70	140	280	420	560	700	Volts
DC Blocking Voltage	V_R	50	100	200	400	600	800	1000	Volts
Average Forward Current	$I_{F(AV)}$	1.0							Amps
Peak Forward Surge Current: 8.3ms single half sine-wave superimposed on rated load (JEDEC Method)	I_{FSM}	30.0							Amps
Forward Voltage at 1.0A	V_F	1		1.4		1.7		Volts	
DC Reverse Current at Rated DC Blocking Voltage	I_R	5							μA
Typical Thermal Resistance (NOTE 1)	$R_{\theta JA}$	50							°C/W
Reverse recovery time (NOTE 2)	T_{rr}	50				75			ns
Typical Total Capacitance (Note3)	C_T	20				10			pF
Operating junction and storage temperature range	T_J, T_{STG}	-55~+150							°C

Notes:

- (1) P.C.B. mounted with 0.2x0.2"(5.0x5.0mm) copper pad areas
- (2) Reverse recovery time test condition: $I_F=0.5A$ $I_R=1.0A$ $I_{rr}=0.25A$
- (3) Measured at 1.0MHz and applied reverse voltage of 4.0V DC.

Rating and Characteristics Curves

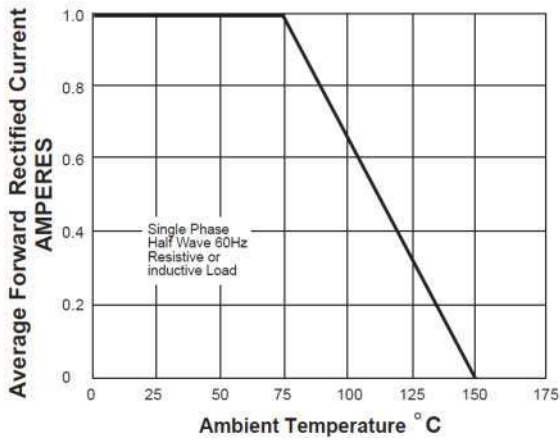

Fig. 1 Forward Current Derating Curve

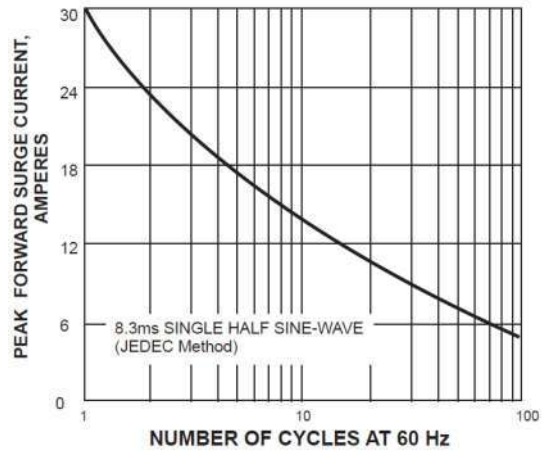

Fig. 2 Typical Junction Capacitance

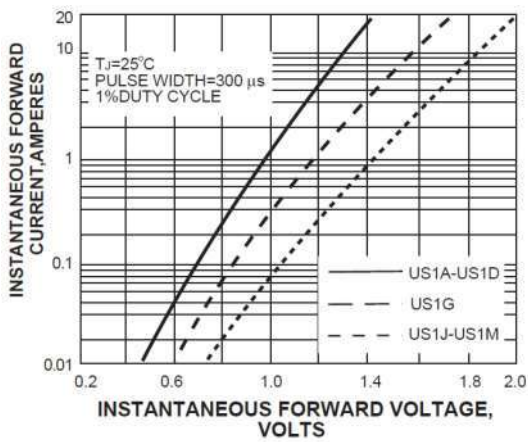

Fig. 3 Typical Reverse Characteristics

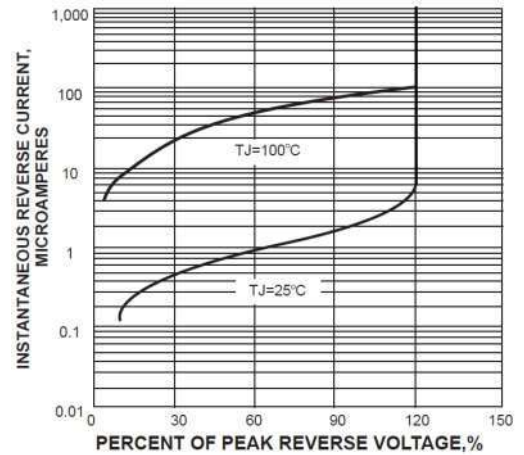

Fig. 4 Typical Forward Characteristics

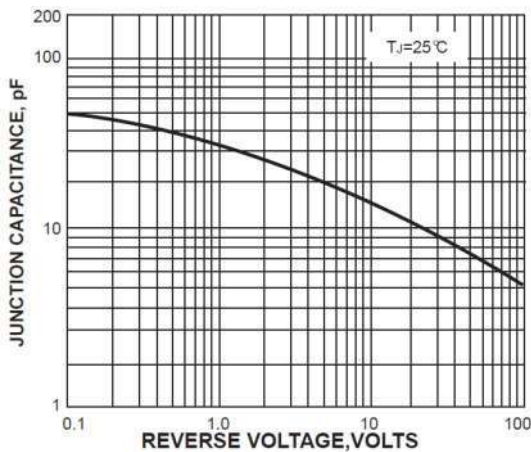

Fig. 5 Typical Reverse Characteristics

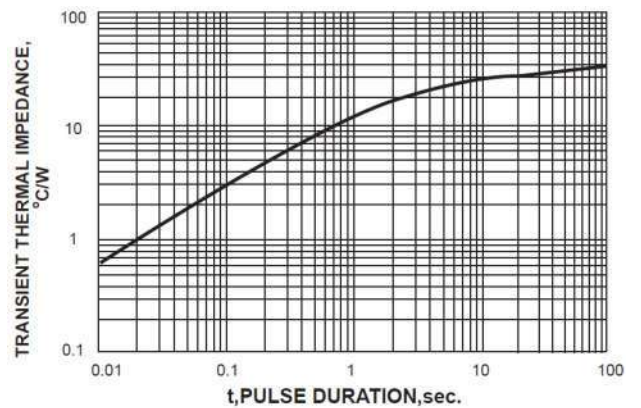
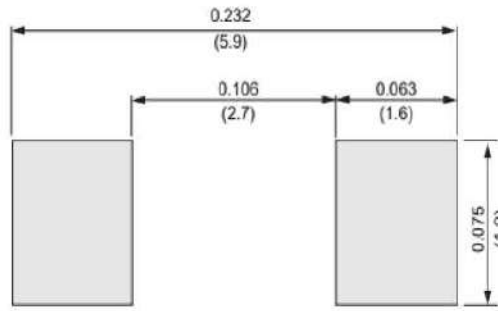

Fig. 6 Typical Transient Thermal Impedance

Pad Layout



Unit:mm

Packaging Specifications

Package	A0 (mm)	B0 (mm)	K0 (mm)	D0 (mm)	E (mm)	F (mm)	P0 (mm)	P1 (mm)	P2 (mm)	T (mm)	W (mm)
SMA	2.8±0.1	5.33±0.1	2.36±0.1	1.55±0.1	1.75±0.1	5.50±0.1	4.0±0.1	4.0±0.01	2±0.1	0.25±0.1	9.4±0.1
SMB	3.8±0.1	5.40±0.1	2.45±0.1	1.55±0.1	1.75±0.1	5.50±0.1	4.0±0.1	8.0±0.01	2±0.1	0.25±0.1	9.4±0.1
SMC	6.05±0.1	8.31±0.1	2.54±0.1	1.55±0.1	1.75±0.1	7.50±0.1	4.0±0.1	8.0±0.05	2±0.1	0.25±0.1	12±0.1

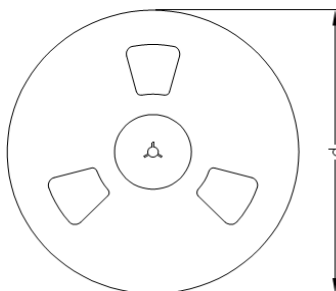
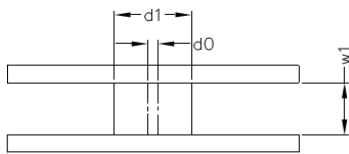
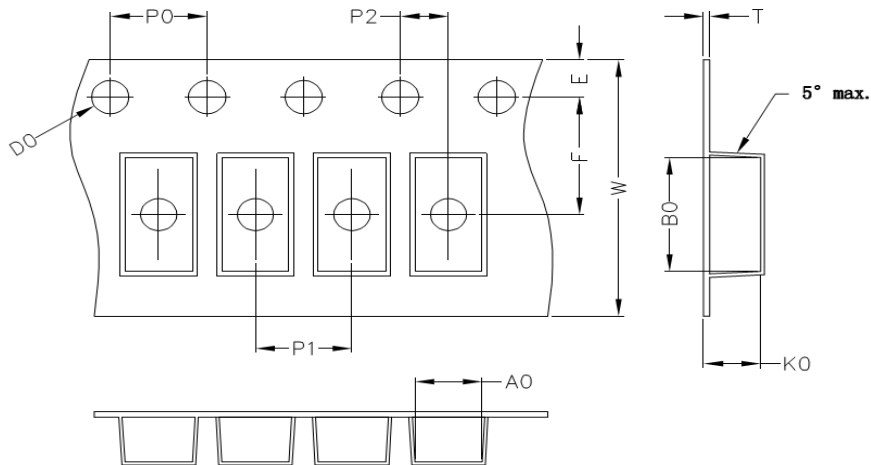

Package	D1 (mm)	D0 (mm)	W1 (mm)	D (mm)
SMA	75	13.5	13.5	330
SMB	75	13.5	13.5	330
SMC	75	13.5	17.0	330

NOTE : The tolerance of reel is ±2mm

Recommand IR Reflow Soldering Thermal Profile

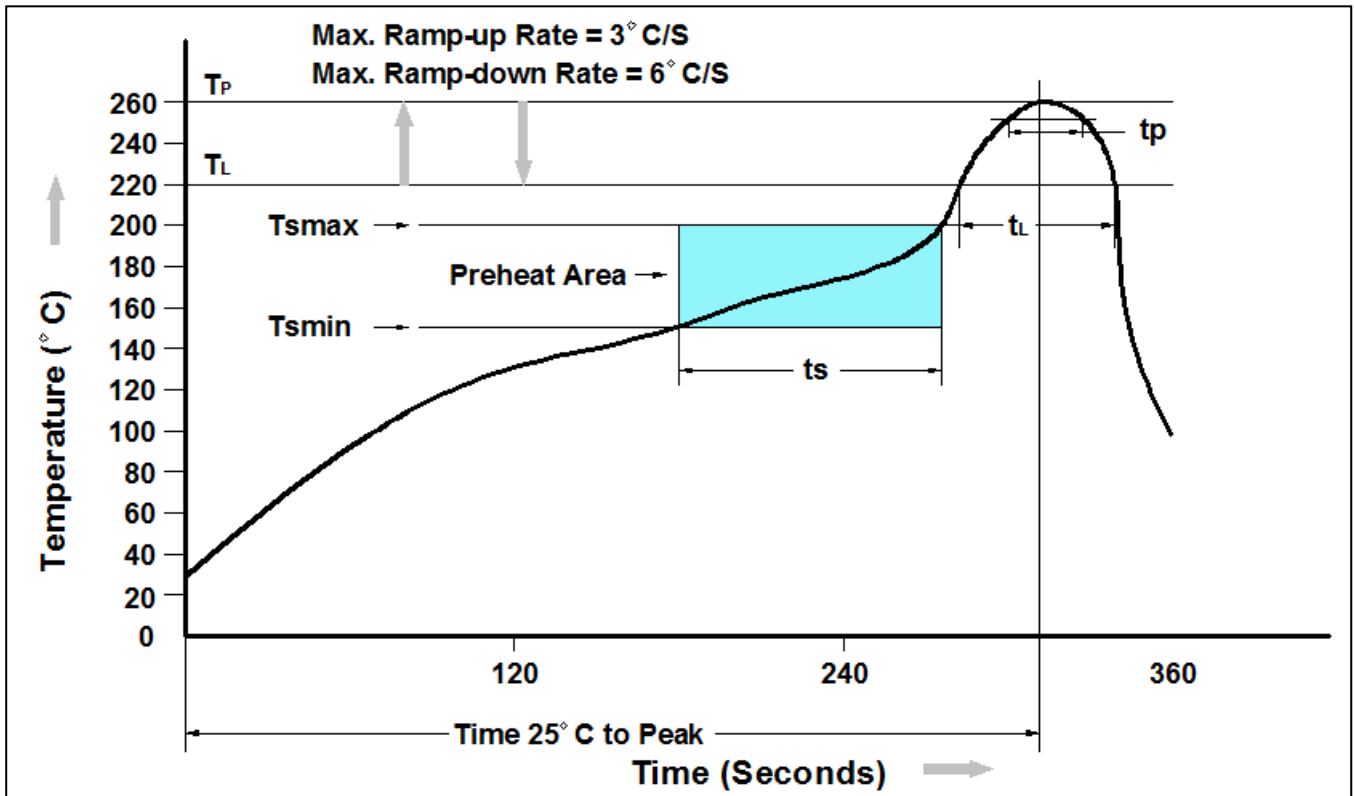

Profile Feature	Pb-Free Assembly Profile
Temperature Min. (T Amin)	150°C
Temperature Max. (Tsmax)	200°C
Time (ts) from (T Amin to Tsmax)	60-120 seconds
Average Ramp-up Rate (tL to tP)	3°C/second max.
Liquidous Temperature (TL)	217°C
Time (tL) Maintained Above (TL)	60 – 150 seconds
Peak Temperature	260°C +0°C / -5°C
Time (tP) within 5°C of actual Peak Temperature	30 seconds
Ramp-down Rate (TP to TL)	6°C/second max
Time 25°C to Peak Temperature	8 minutes max.

Ordering Information

Part Number	Description	Quantity
US1A~US1M	SMA Reel	5000 pcs

DISCLAIMER

- The information in this document and any product described herein are subject to change without notice and should not be construed as a commitment by Paceleader, Paceleader reserve the right to make changes to the information in this document.
- Though Paceleader make effort to improve product quality and reliability, Product can malfunction and fail due to their inherent electrical sensitivity and vulnerability to physical stress, it is the responsibility of the customer, when utilizing Paceleader products, to comply with the standards of safety in making a safe design for entire system and to avoid situation in which a malfunction or failure., In developing a new designs, customer should ensure that the device which shown in this documents are used within specified operating ranges.
- The information contained herein is presented only as a guide for the applications of our products. No responsibility is assumed by Paceleader for any infringements of patents or other rights of the third parties which may result from its use.