

Primary Characteristics

I_F	2	A
V_{RRM}	20~200	V
I_{FSM}	50	A
V_F	0.50~0.90	V

Features

- Low profile package
- Ideal for automated placement
- Guard Ring for over voltage protection
- Low forward voltage drop
- Component in accordance to RoHS 2002/95/EC

Mechanical Data

- Cases: DO-214AC(SMA)
- Case Material: Molded Plastic. UL Flammability Classification Rating 94V-0
- Terminals: Lead free Plating (Tin Finish)
Solderable per MIL-STD-202, Method 208
- Polarity: Cathode Band
- Weight: 0.062 grams (approximate)

Package Outline Dimensions

SMA

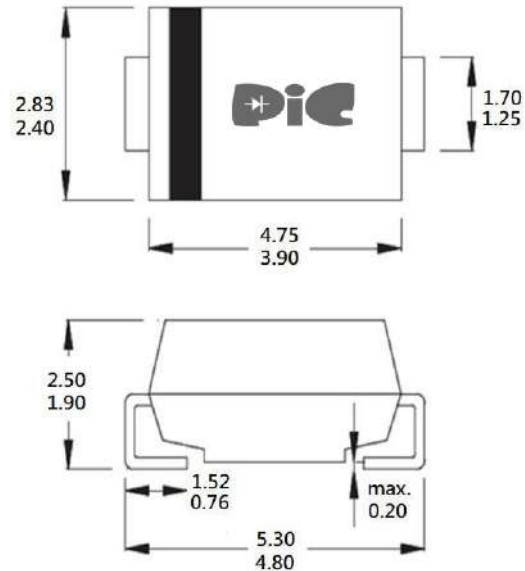

Dimensions in inches and millimeters

Maximum Ratings (TA=25°C unless otherwise noted)

PARAMETER	SYMBOL	SK22	SK23	SK24	SK25	SK26	SK28	SK210	SK215	SK220	UNIT	
Maximum repetitive peak reverse voltage	V_{RRM}	20	30	40	50	60	80	100	150	200	V	
Maximum RMS voltage	V_{RMS}	14	21	28	35	42	56	70	105	140	V	
Maximum DC blocking voltage	V_{DC}	20	30	40	50	60	80	100	150	200	V	
Maximum average forward rectified current	I_F	2.0									A	
Peak forward surge current, 8.3ms single half sine-wave superimposed on rated load	I_{FSM}	50.0									A	
Maximum Instantaneous Forward Voltage IF=2A @ 25°C	V_F	0.50			0.70		0.85		0.87	0.90	V	
Maximum DC Reverse Current @ TA=25°C at Rated DC Blocking Voltage @ TA=100°C	I_R	0.5 15					0.2 5.0				mA	
Typical Junction Capacitance(NOTE1)	C_j	125			70			55		40	pF	
Critical rate of rise of reverse voltage (rated VR, Tj=25°C)	dV/dt	10,000									V/us	
Typical Thermal Resistance	$R_{\theta JC}$	40									°C/W	
Operating Temperature Range	T_J	-55 to +125					-55 to +150					°C
Storage Temperature Range	T_{STG}	-55 to +150									°C	

NOTES:

1. Measured at 1.0MHZ and applied reverse voltage of 4.0V DC

Rating and Characteristics Curves

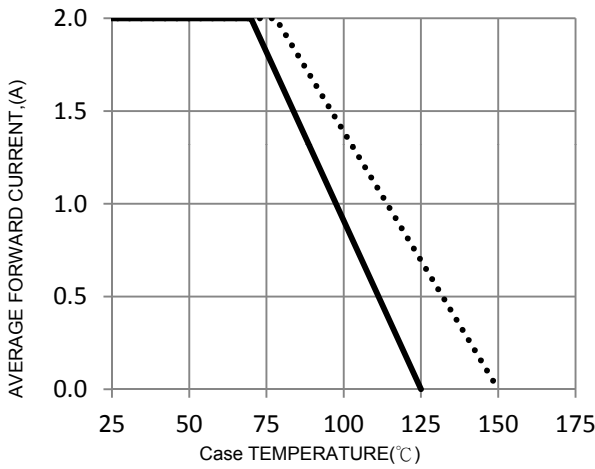

FIG. 1-Typical Forward Current Derating Curve

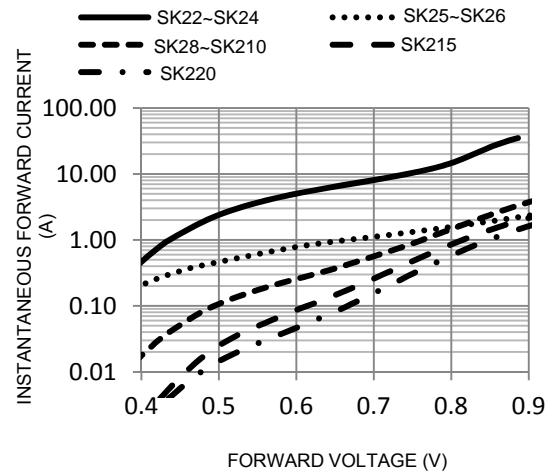

FIG. 2-Typical Forward Characteristics

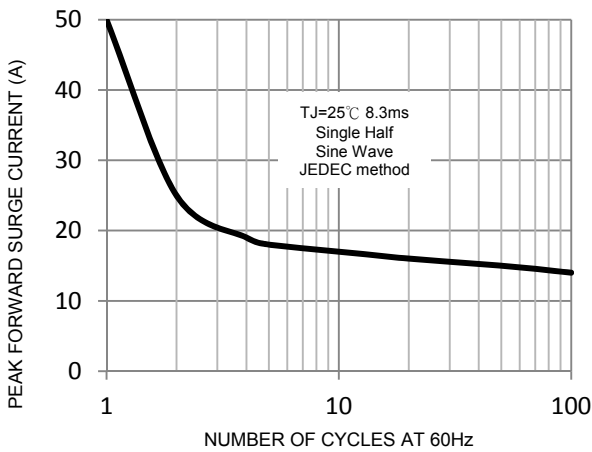

FIG. 3-Maximum Non-Repetitive Forward Surge Current

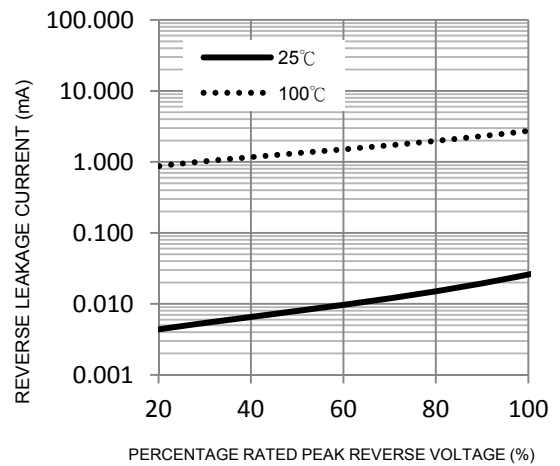

FIG. 4-Typical Reverse Characteristics

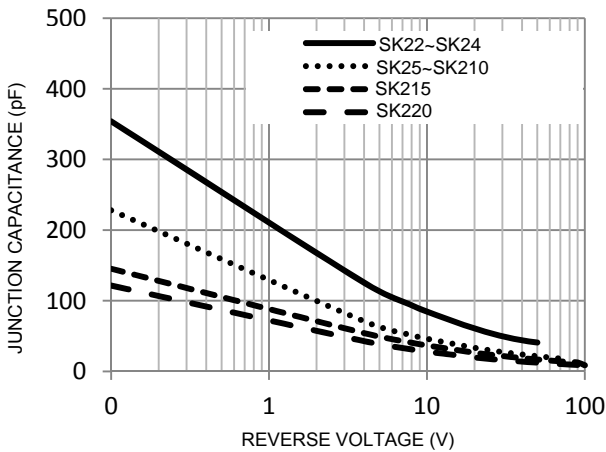
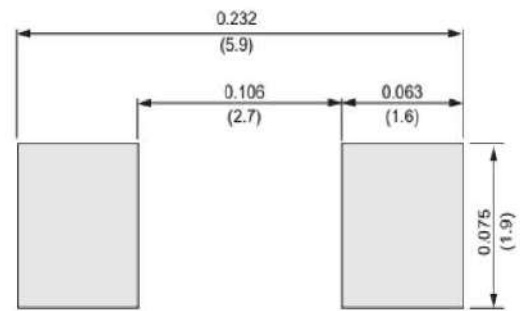

FIG. 5-Typical Junction Capacitance

Pad Layout



Unit:mm

Packaging Specifications

Package	A0 (mm)	B0 (mm)	K0 (mm)	D0 (mm)	E (mm)	F (mm)	P0 (mm)	P1 (mm)	P2 (mm)	T (mm)	W (mm)
SMA	2.8±0.1	5.33±0.1	2.36±0.1	1.55±0.1	1.75±0.1	5.50±0.1	4.0±0.1	4.0±0.01	2±0.1	0.25±0.1	9.4±0.1
SMB	3.8±0.1	5.40±0.1	2.45±0.1	1.55±0.1	1.75±0.1	5.50±0.1	4.0±0.1	8.0±0.01	2±0.1	0.25±0.1	9.4±0.1
SMC	6.05±0.1	8.31±0.1	2.54±0.1	1.55±0.1	1.75±0.1	7.50±0.1	4.0±0.1	8.0±0.05	2±0.1	0.25±0.1	12±0.1

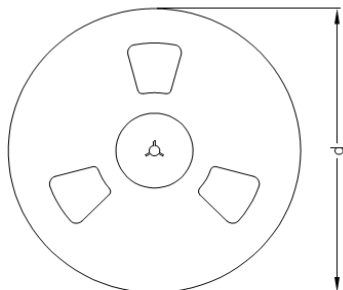
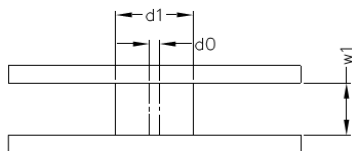
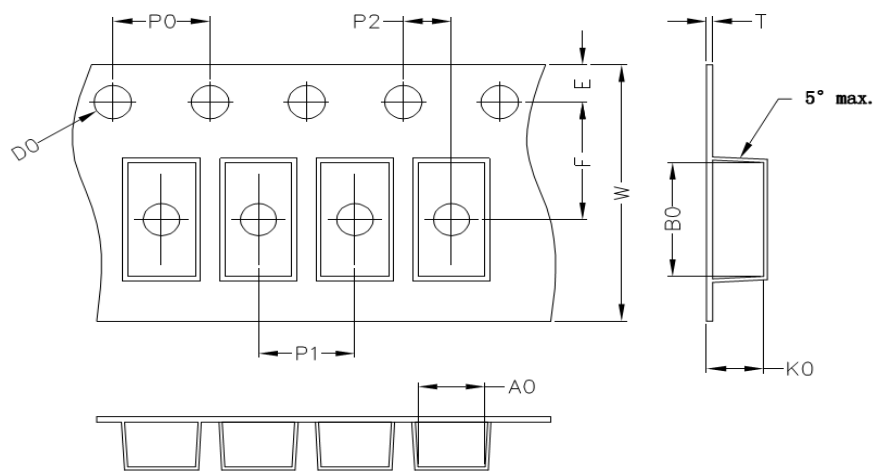

Package	D1 (mm)	D0 (mm)	W1 (mm)	D (mm)
SMA	75	13.5	13.5	330
SMB	75	13.5	13.5	330
SMC	75	13.5	17.0	330

NOTE : The tolerance of reel is ±2mm

Recommend IR Reflow Soldering Thermal Profile

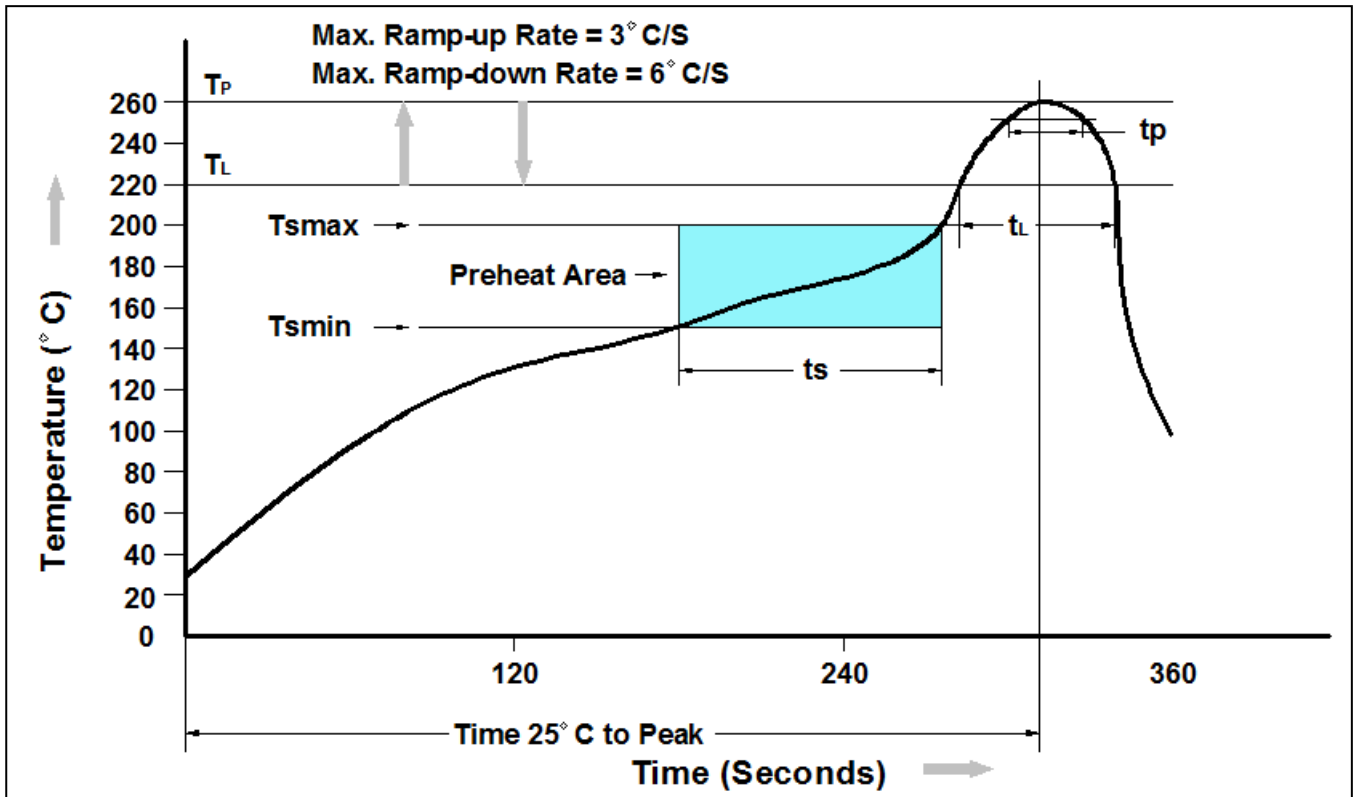

Profile Feature	Pb-Free Assembly Profile
Temperature Min. (T_{smin})	150°C
Temperature Max. (T_{smax})	200°C
Time (t_s) from (T_{smin} to T_{smax})	60-120 seconds
Average Ramp-up Rate (t_L to t_P)	3°C/second max.
Liquidous Temperature (T_L)	217°C
Time (t_L) Maintained Above (T_L)	60 – 150 seconds
Peak Temperature	260°C +0°C / -5°C
Time (t_P) within 5°C of actual Peak Temperature	30 seconds
Ramp-down Rate (T_P to T_L)	6°C/second max
Time 25°C to Peak Temperature	8 minutes max.

Ordering Information

Part Number	Description	Quantity
SK22~SK220	SMA Reel	5000 pcs

DISCLAIMER

- The information in this document and any product described herein are subject to change without notice and should not be construed as a commitment by Paceleader, Paceleader reserve the right to make changes to the information in this document.
- Though Paceleader make effort to improve product quality and reliability, Product can malfunction and fail due to their inherent electrical sensitivity and vulnerability to physical stress, it is the responsibility of the customer, when utilizing Paceleader products, to comply with the standards of safety in making a safe design for entire system and to avoid situation in which a malfunction or failure., In developing a new designs, customer should ensure that the device which shown in this documents are used within specified operating ranges.
- The information contained herein is presented only as a guide for the applications of our products. No responsibility is assumed by Paceleader for any infringements of patents or other rights of the third parties which may result from its use.