

### Primary Characteristics

$I_F$	1	A
$V_{RRM}$	20~40	V
$I_{FSM}$	40	A
$V_F$	0.45~0.5	V

### Features

- For surface mount applications
- Low profile package
- Built-in strain relief
- Easy pick and place
- Low forward voltage drop
- Metal to silicon rectifier, majority carrier conduction
- Low power loss, high efficiency
- High current and surge capability
- Plastic package has Underwriters Laboratory Flammability Classification 94V-0
- High temperature soldering :  
250°C/10 seconds at terminals

### Package Outline Dimensions

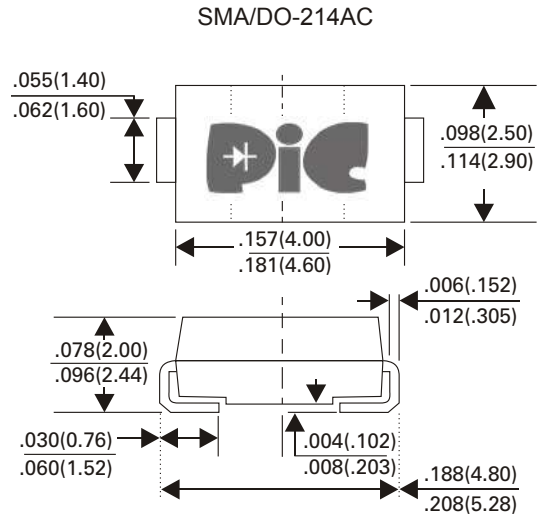

Dimensions in inches and (millimeters)

### Mechanical Data

Case : JEDEC DO-214AC molded plastic  
 Terminals : Solder plated, solderable per  
 MIL-STD-202, Method 208  
 Polarity : Color band denotes cathode end  
 Standard Package : 12mm tape (EIA STD EIA-481)  
 Weight : 0.002 ounce, 0.064gram

### MAXIMUM RATINGS AND ELECTRICAL CHARACTERISTICS

Ratings at 25°C ambient temperature unless otherwise specified  
 Single phase, half wave, 60Hz, resistive or inductive load  
 For capacitive load, derate current by 20%

	SYMBOL	FM5817	FM5818	FM5819	UNITS
Maximum Repetitive Peak Reverse Voltage	$V_{RRM}$	20	30	40	Volts
Maximum RMS Voltage	$V_{RMS}$	14	21	28	Volts
Maximum DC Blocking Voltage	$V_{DC}$	20	30	40	Volts
Maximum Average Forward Rectified Current at $T_L$ (Figure 1)	$I_{(AV)}$	1.0			Amps
Peak Forward Surge Current 8.3ms Single Half Sine-Wave Superimposed on Rated Load (JEDEC Method)	$I_{FSM}$	40			Amps
Maximum Instantaneous Forward Voltage at 1.0A	$V_F$	0.45	0.5		Volts
Maximum DC Reverse Current (NOTE 1) $T_A=25^\circ\text{C}$ at Rated DC Blocking Voltage $T_A=100^\circ\text{C}$	$I_R$	0.5 10			mA
Maximum Thermal Resistance (NOTE 2)	$R_{\theta JA}$ $R_{\theta JL}$	88 28			$^\circ\text{C} / \text{W}$
Typical Junction Capacitance (NOTE 3)	$C_J$	110			pF
Storage and Operating Temperature Range	$T_J$ $T_{STG}$	-55 to +150			$^\circ\text{C}$

#### NOTES :

1. Pulse test with 300  $\mu\text{s}$  PULSE WIDTH, 1% duty cycle
2. P.C.B. mounted on 0.2x0.2" (5.0x5.0mm)copper pad areas
3. Measured at 1.0MHz and applied reverse voltage of 4.0 volts

## Rating and Characteristics Curves

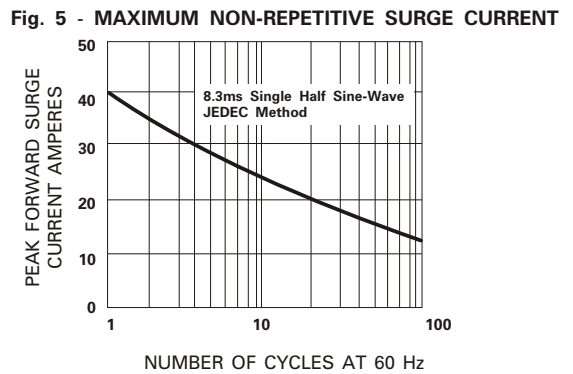
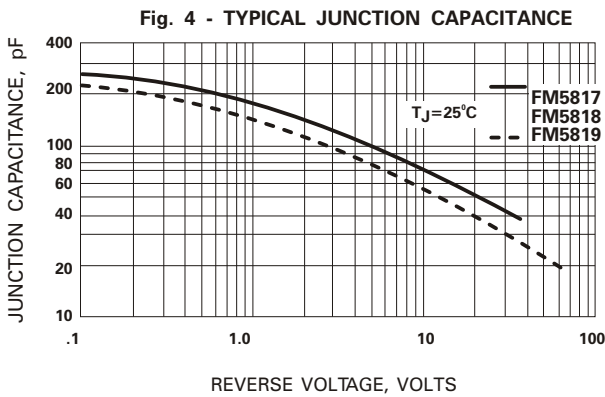
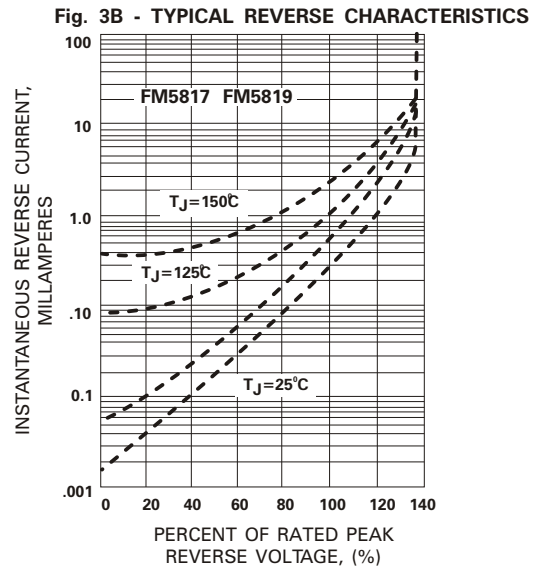
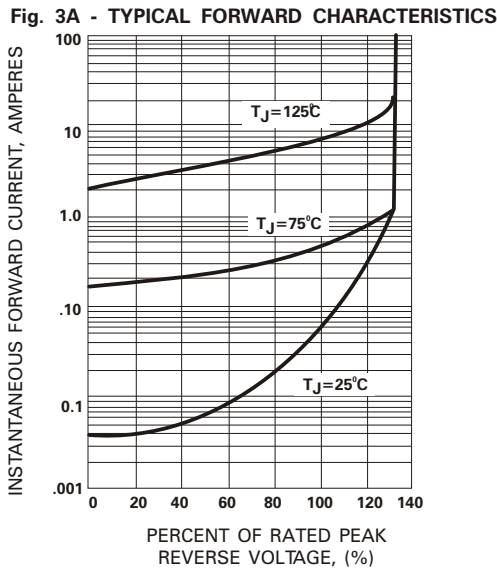
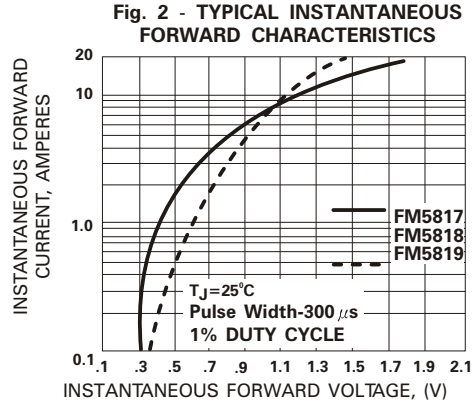
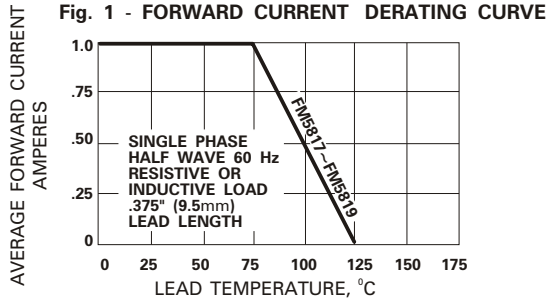

## Pad Layout

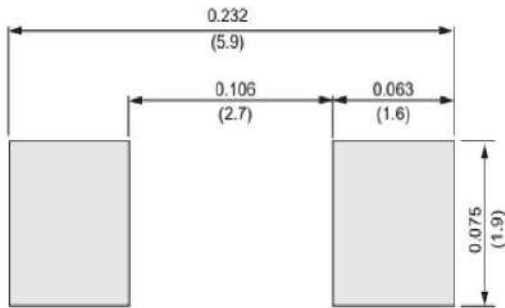

Unit: mm

## Packaging Specifications

Package	A0 (mm)	B0 (mm)	K0 (mm)	D0 (mm)	E (mm)	F (mm)	P0 (mm)	P1 (mm)	P2 (mm)	T (mm)	W (mm)
SMA	2.8±0.1	5.33±0.1	2.36±0.1	1.55±0.1	1.75±0.1	5.50±0.1	4.0±0.1	4.0±0.01	2±0.1	0.25±0.1	9.4±0.1
SMB	3.8±0.1	5.40±0.1	2.45±0.1	1.55±0.1	1.75±0.1	5.50±0.1	4.0±0.1	8.0±0.01	2±0.1	0.25±0.1	9.4±0.1
SMC	6.05±0.1	8.31±0.1	2.54±0.1	1.55±0.1	1.75±0.1	7.50±0.1	4.0±0.1	8.0±0.05	2±0.1	0.25±0.1	12±0.1

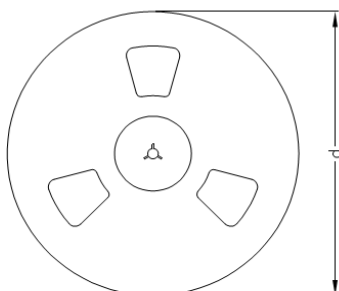
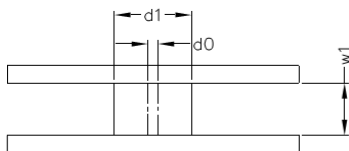
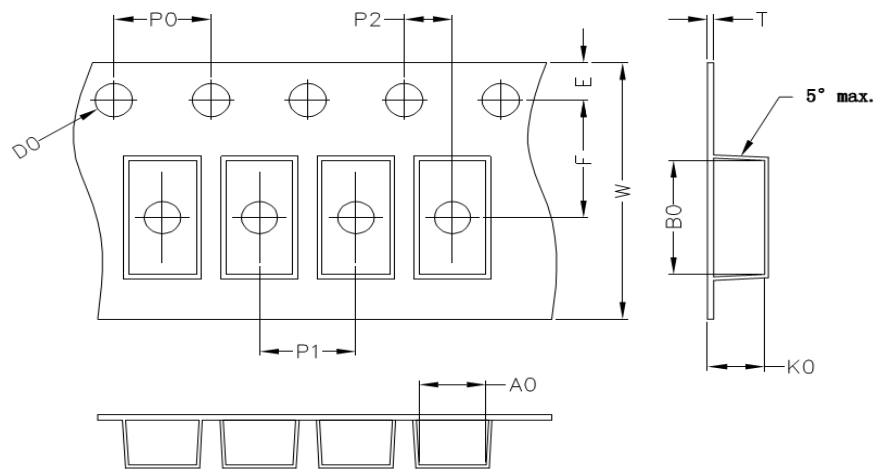

Package	D1 (mm)	D0 (mm)	W1 (mm)	D (mm)
SMA	75	13.5	13.5	330
SMB	75	13.5	13.5	330
SMC	75	13.5	17.0	330

NOTE : The tolerance of reel is ±2mm

Recommend IR Reflow Soldering Thermal Profile

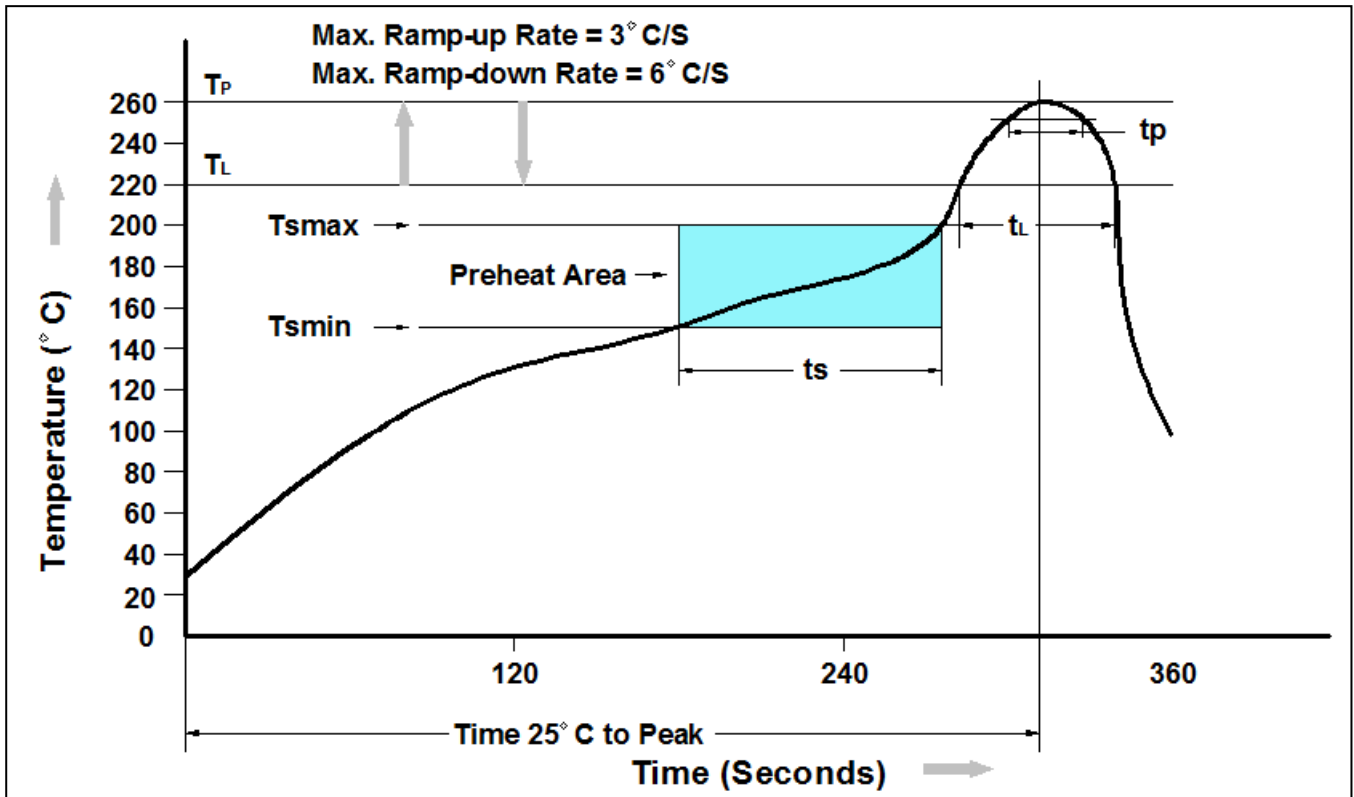

Profile Feature	Pb-Free Assembly Profile
Temperature Min. (T <sub>smin</sub> )	150°C
Temperature Max. (T <sub>smax</sub> )	200°C
Time (t <sub>s</sub> ) from (T <sub>smin</sub> to T <sub>smax</sub> )	60-120 seconds
Average Ramp-up Rate (t <sub>L</sub> to t <sub>P</sub> )	3°C/second max.
Liquidous Temperature (T <sub>L</sub> )	217°C
Time (t <sub>L</sub> ) Maintained Above (T <sub>L</sub> )	60 – 150 seconds
Peak Temperature	260°C +0°C / -5°C
Time (t <sub>P</sub> ) within 5°C of actual Peak Temperature	30 seconds
Ramp-down Rate (T <sub>P</sub> to T <sub>L</sub> )	6°C/second max
Time 25°C to Peak Temperature	8 minutes max.

Ordering Information

Part Number	Description	Quantity
FM5817~FM5819	SMA Reel	5000 pcs

## DISCLAIMER

- The information in this document and any product described herein are subject to change without notice and should not be construed as a commitment by Paceleader, Paceleader reserve the right to make changes to the information in this document.
- Though Paceleader make effort to improve product quality and reliability, Product can malfunction and fail due to their inherent electrical sensitivity and vulnerability to physical stress, it is the responsibility of the customer, when utilizing Paceleader products, to comply with the standards of safety in making a safe design for entire system and to avoid situation in which a malfunction or failure., In developing a new designs, customer should ensure that the device which shown in this documents are used within specified operatingranges.
- The information contained herein is presented only as a guide for the applications of our products. No responsibility is assumed by Paceleader for any infringements of patents or other rights of the third parties which may result from its use.